

1. A Tribute to Prof. Zhi-Tang Huang (ZH-466DT)

Mei-Xiang Wang, Chu-Yi Yu, Qi-Yu Zheng, Chuan-Feng Chen and Mei-Xin Zhao

Full Text: [PDF \(131K\)](#)

pp. 1 - 6

accepted Jul 31 2002; published Nov 21 2002;

2. An improved formal total synthesis of (-)-anisomycin (ZH-531DP)

Pei-Qiang Huang and Xiao Zheng

Full Text: [PDF \(173K\)](#)

pp. 7 - 14

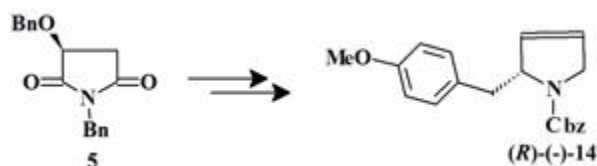

received Jul 5 2002; accepted Sep 24 2002; published Sep 26 2002;

3. Asymmetric hydroarylation of hetero-atom containing norbornene derivatives and enantioselective synthesis of analogs of epibatidine (ZH-555DP)

Xiao-Guang Li, Fang-Yi Tang, Hua-Dong Xu, Xin-Yan Wu and Qi-Lin Zhou

Full Text: [PDF \(84K\)](#)

pp. 15 - 20

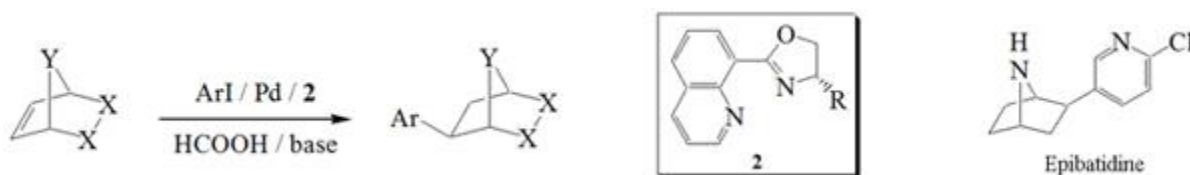

received Sep 13 2002; accepted Nov 4 2002; published Nov 23 2002;

4. Asymmetric reactions catalyzed by chiral titanium complexes (ZH-560DR)

Fuxue Chen, Xiaoming Feng and Yaozhong Jiang

Full Text: [PDF \(262K\)](#)

pp. 21 - 31

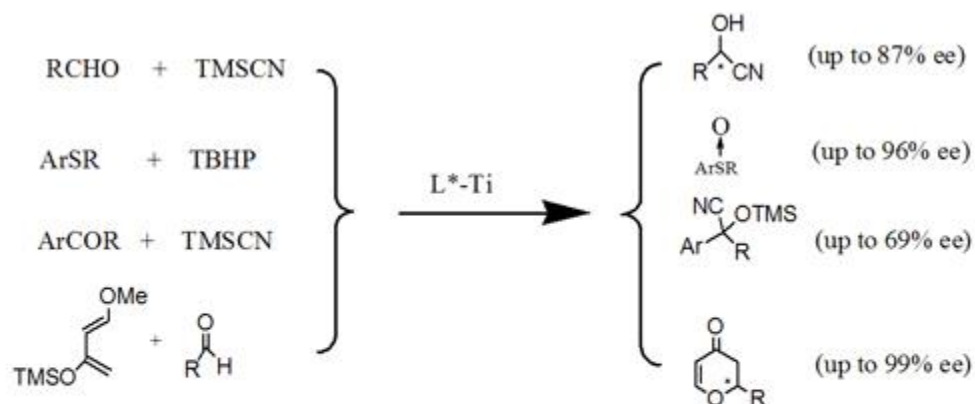

Chiral Ti(IV) complexes as catalyst for, asymmetric oxa-Diels-Alder reaction (99% ee), oxidation of sulfides for sulfoxides (up to 96% ee), silylcyanation of aldehydes (up to 87% ee) and ketones (up to 69% ee) are reviewed.

received Sep 18 2002; accepted Nov 4 2002; published Dec 2 2002;

5. Synthesis of DNA-recognizing polyamides containing *N*-methylpyrrole and *N*-methylimidazole (ZH-569DP)

Gu Yuan and Feili Tang

Full Text: [PDF \(141K\)](#)

pp. 32 - 37

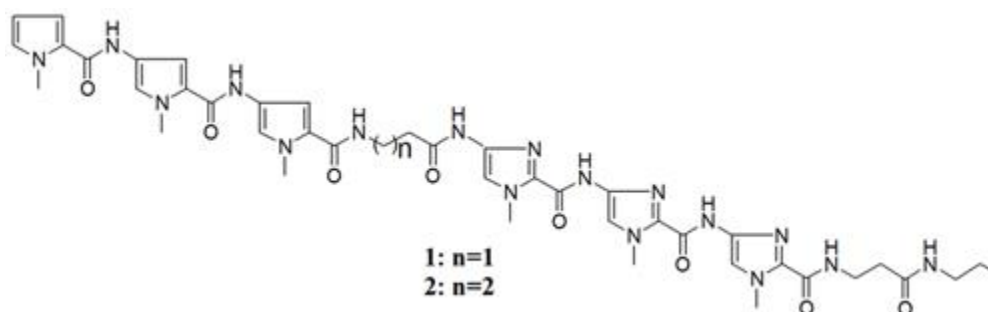

received Oct 7 2002; accepted Nov 8 2002; published Dec 6 2002;

6. The reaction of a bis(spirodienone) calix[4]arene derivative with hydrazine (ZH-591DP)

Flavio Grynszpan and Silvio E. Biali

Full Text: [PDF \(424K\)](#)

pp. 38 - 48

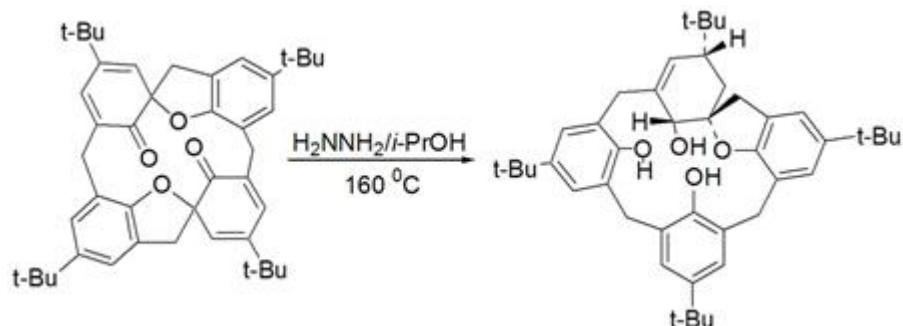

received Oct 28 2002; accepted Dec 4 2002; published Dec 20 2002;

7. The preparation of 5-substituted and 4,5-disubstituted 2,1-benzisoxazoles (ZH-585DP)

Alan R. Katritzky, Zuoquan Wang, C. Dennis Hall and Novruz G. Akhmedov

Full Text: [PDF \(226K\)](#)

pp. 49 - 58

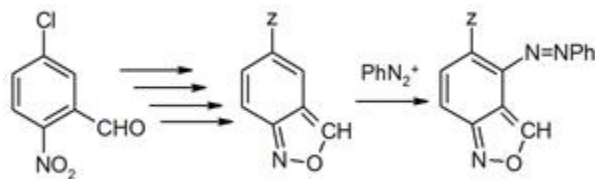

received Oct 21 2002; accepted Jan 3 2003; published Jan 6 2003;

8. Design and syntheses of efficient and thermally stable diamino chromophores for NLO application (ZH-587DP)

Wei Wu, Cheng Ye and Dong Wang

Full Text: [PDF \(276K\)](#)

pp. 59 - 69

A review with 17 references

received Oct 25 2002; accepted Jan 20 2003; published Jan 28 2003;

9. Progress in molecular diversity of tonghaosu and its analogs (ZH-614DP)

Biao-Lin Yin, Jun-Fa Fan, Yang Gao and Yu-Lin Wu

Full Text: [PDF \(160K\)](#)

pp. 70 - 83

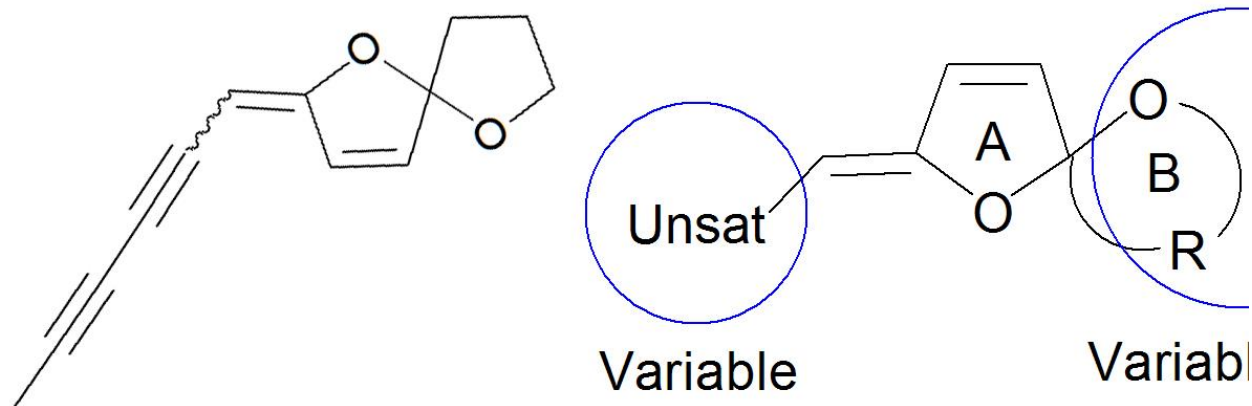

Tonghaosu

Analogs of tonghaosu

received Nov 29 2002; accepted Jan 20 2003; published Jan 28 2003;

10. Catalytic asymmetric S-H insertion reaction of carbenoids (ZH-608DP)

Xiaomei Zhang, Ming Ma and Jianbo Wang

Full Text: [PDF \(131K\)](#)

pp. 84 - 91

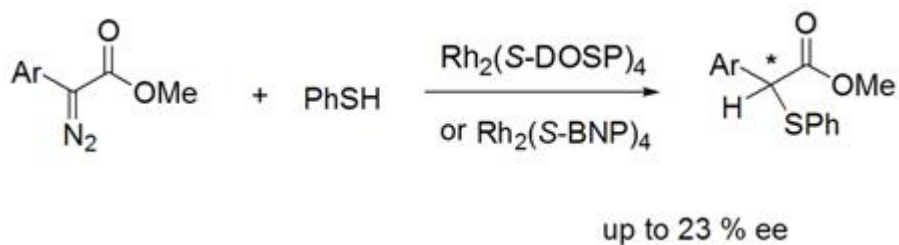

received Nov 17 2002; accepted Jan 28 2003; published Feb 19 2003;

11. Two different conformations of 25,27-bis(3-pyridylcarboxylate)- 26,28-dihydroxy-calix[4]arene in solid state (ZH-601DP)

Heng-Yi Zhang, Hao Wang and Yu Liu

Full Text: [PDF \(194K\)](#)

pp. 92 - 97

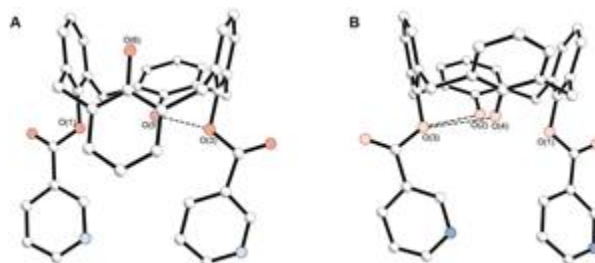

received Nov 13 2002; accepted Jan 29 2003; published Feb 19 2003;

12. Novel 6-azapteridines and oxazinotriazines from bifunctional 1,2,4-triazines (ZH-624DP)

Heinrich Wamhoff and Milena Tzanova

Full Text: [PDF \(127K\)](#)

pp. 98 - 102

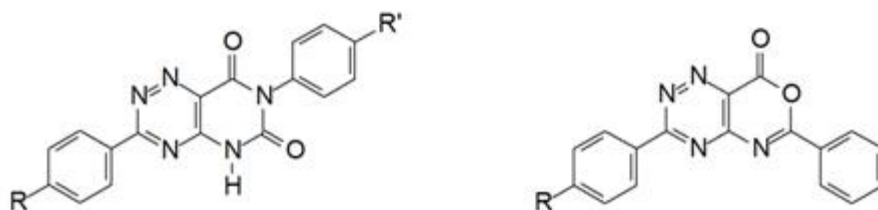

R, Cl, CH₃O

received Dec 17 2002; accepted Feb 24 2003; published Mar 4 2003;

13. Synthetic approach to microsclerodermins: construction of three building blocks (ZH-636DP)

Takayuki Shioiri, Shigekazu Sasaki and Yasumasa Hamada

Full Text: [PDF \(439K\)](#)

pp. 103 - 122

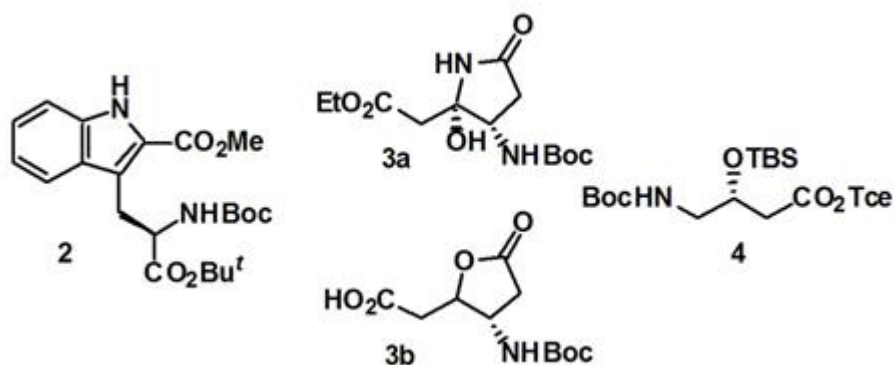

received Jan 1 2003; accepted Feb 24 2003; published Mar 5 2003;

14. Chiral BINOL-centered dendrimers for the enantioselective Lewis acid catalyzed diethylzinc addition to aldehydes (ZH-634DP)

Guo-Hua Liu, Qing-Hua Fan, Xi-Qiang Yang and Xiao-Min Chen

Full Text: [PDF \(222K\)](#)

pp. 123 - 132

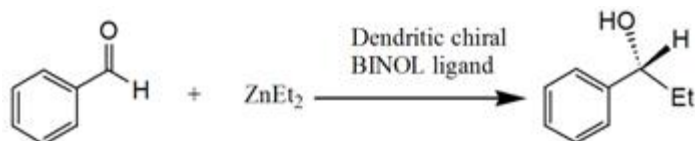

received Dec 31 2002; accepted Apr 29 2003; published May 8 2003;

15. A new chiral heterocyclic 1,1-enediamine as a precursor to piperidines (ZH-737DP)

Raymond C. F. Jones and Simon C. Hirst

Full Text: [PDF \(106K\)](#)

pp. 133 - 140

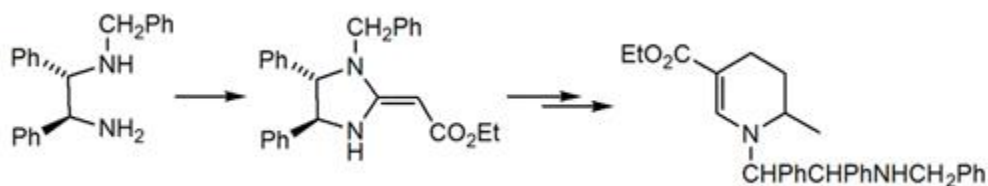

received Mar 15 2003; accepted May 2 2003; published May 11 2003;

16. Synthesis and insecticidal activity of 1,2,4-triazole derivatives (ZH-700DP)

Bing Chai, XuhongQian, Song Cao, Haidong Liu and GonghuaSong

Full Text: [PDF \(136K\)](#)

pp. 141 - 145

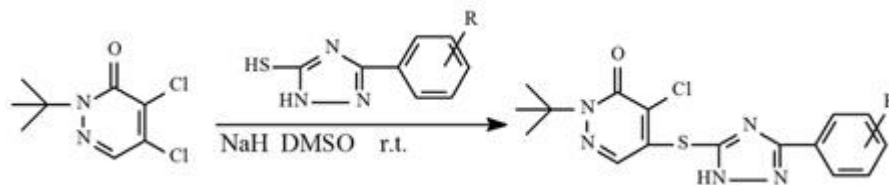

received Feb 21 2003; accepted May 10 2003; published May 14 2003;

17. Synthesis of fused N-heterocycles utilizing the heterocyclic enamine protocol (ZH-702DP)

Yong Liu, Chu-Yi Yu and Mei-Xiang Wang

Full Text: [PDF \(116K\)](#)

pp. 146 - 154

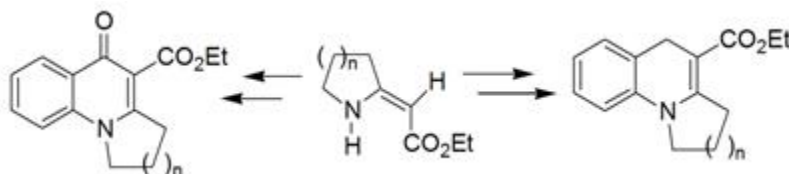

received Feb 21 2003; accepted May 11 2003; published May 17 2003;

18. Preparation of S-containing heterocycles via novel reaction patterns of carbon disulfide with 1-lithiobutadienes and 1,4-dilithiobutadienes (ZH-617DP)

Congyang Wang, Jinglong Chen, Qiuling Song, Zhiping Li and Zhenfeng Xi

Full Text: [PDF \(267K\)](#)

pp. 155 - 164

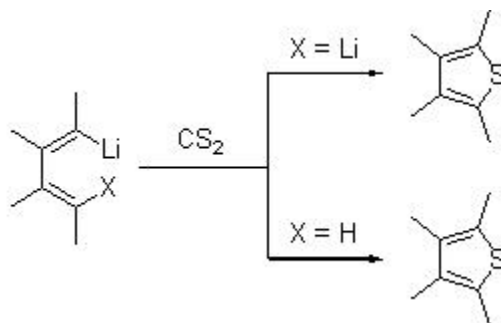

received Dec 4 2002; accepted May 27 2003; published May 30 2003;

19. Synthesis and new reaction of sulfur-containing heterocycles for studies of organic conducting materials (ZH-692DP)

Deqing Zhang, Wei Xu, Chunyang Jia, Hongxiang Li and Daoben Zhu

Full Text: [PDF \(78K\)](#)

pp. 165 - 172

A review with 26 references

received Feb 15 2003; accepted May 10 2003; published May 30 2003;

20. A study on the fluorescence quenching of modified β -cyclodextrin by transition metal ions in different solvents (ZH-683DP)

Hui Wang, Minghua Mei, Hongzhi Xie, Yu Fang, Xiaohong Zhang and Shikang Wu

Full Text: [PDF \(364K\)](#)

pp. 173 - 181

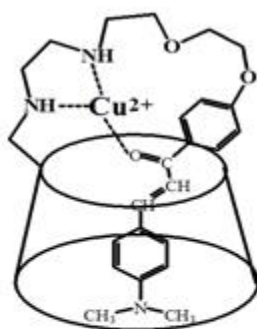

The configuration of DMAC-CD when it
complexes with Cu^{2+} in aqueous solution

received Feb 11 2003; accepted Jun 2 2003; published Jun 6 2003;

21. Intramolecular triplet energy transfer in benzophenone-{crown ether}-naphthalene system (ZH-701DP)

Xiao-He Xu, Bin Chen, Li-Zhu Wu, Li-Ping Zhang and Chen-Ho Tung

Full Text: [PDF \(302K\)](#)

pp. 182 - 190

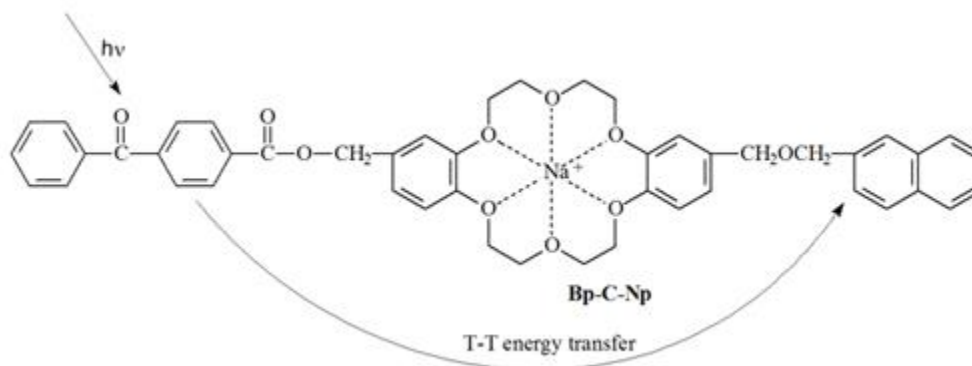

received Feb 21 2003; accepted May 26 2003; published Jun 6 2003;

22. Chemical reactions in supercritical carbon dioxide (ZH-685DR)

Zou Gang, Jiang Huan-Feng and Chen Ming-Cai

Full Text: [PDF \(131K\)](#)

pp. 191 - 198

A review with 33 references

received Feb 11 2003; accepted Jun 30 2003; published Jul 5 2003;